

White Paper



## Gigabit Ethernet over fiber optics



Convincing cabling solutions

## Contents

### Gigabit Ethernet over fiber optics

	Page
1. LAN cabling on its way towards 10 Gigabit Ethernet .....	3
2. Standardised fiber optic Gigabit and 10 Gigabit Ethernet applications.....	4
3. Structured cabling systems in accordance with ISO/IEC 11801 and EN 50173-1 .....	5
3.1. Optical channel definition .....	5
3.2. Multimode fiber categories .....	6
3.3. Singlemode fiber categories.....	6
3.4. Plug connections .....	7
3.5. Fusion splices.....	8
4. Optimised fibers for Gigabit and 10 Gigabit Ethernet applications .....	8
4.1. Increasing bandwidth with MM fibers of category OM3 .....	8
4.2. SM fiber types and their use in Gigabit and 10 Gigabit Ethernet.....	10
5. Gigabit and 10 Gigabit Ethernet applications in ISO/IEC 11801 and EN50173-1 .....	11
6. The correlation between channel, class, bandwidth and loss.....	12
Conclusions for R&M.....	13
6.1. Plug connector.....	13
6.2. Fiber loss .....	13
6.3. Fiber bandwidth.....	13
6.4. Example calculations.....	14
7. Prognosis.....	15
8. Annex: Further standardised MM fiber types .....	16

© Copyright 2004 Reichle & De-Massari AG (R&M). All rights reserved.

This publication or parts out of it may not be copied or distributed in any form or for any purpose without the express written authorisation of Reichle & De-Massari AG. Any information contained in this publication can be changed without prior notice. Utmost care went into creating this document. The information it contains reflects product specifications at the time of publication. Subject to changes in technical specifications.

Ethernet is gaining in speed and the distances it can cover are growing too. With 10 Gigabit Ethernet in store the standard LAN protocol family can successfully compete against customary long-distance transmission technologies. The obvious transmission medium of choice is optical fiber. In return, optical fibers with their high bandwidths are on their way into the LAN sector. The new standards for structured cabling systems, ISO/IEC 11801 and EN 50173-1 include 10 Gigabit Ethernet applications over optical fibers. Yet, there is some confusion regarding standards, definitions, and the many types of fibers and connectors. What are today's relevant parameters, what are tomorrow's? The key question is what investments make a network future-proof? This white paper will provide relevant technical information and help to make the right decisions.

Application:	Enterprise Cabling
Technology:	Fiber Optics
Format:	White Paper
Topics:	Standards, fiber types, bandwidths and distances, channel definition and connector types
Objective:	Examine fiber classes and fiber categories in fiber optic applications
Target audience:	Decisions makers, planners, R&M Sales
Authors:	Hannelore Hirscher, Thomas Richner
Publishing date:	March 2004

## 1. LAN cabling on its way towards 10 Gigabit Ethernet

The bandwidth demand of a business doubles every twelve months. Data traffic in short and long-distance networks also doubles every six to twelve months. Against that backdrop the average service life of 20 years of a LAN (Local Area Network) cabling system seems like an eternity. During that period of time, the active network is replaced twice on average, the PCs four times, and the software is updated up to five times.

This discrepancy is the reason why demands on a cabling system grow out of proportion. It must not only run all applications but also guarantee investment protection for the future.

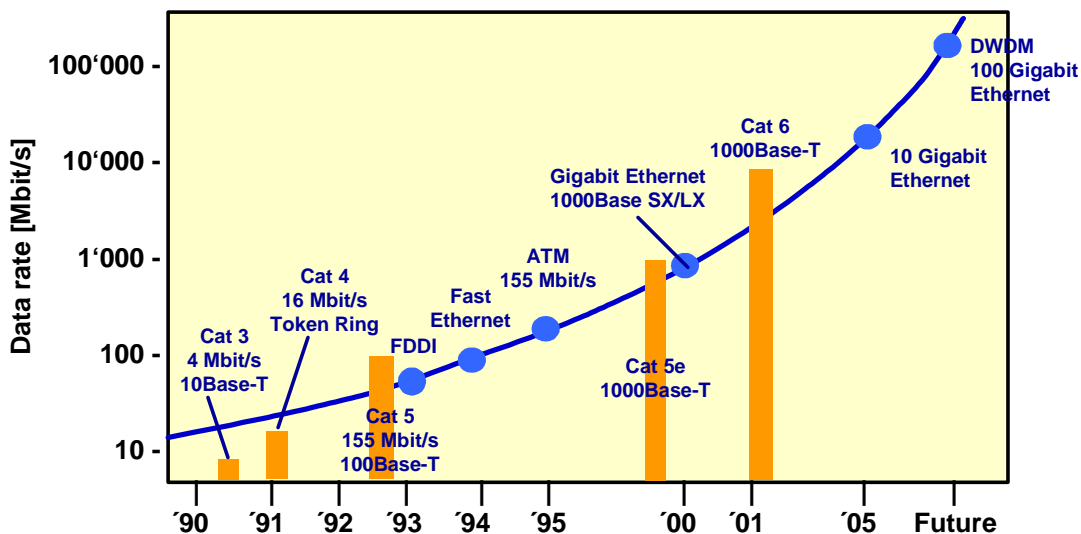

Figure 1: Increasing transmission speeds and corresponding standards

Today, Ethernet is predominant in LAN applications, and is finding its way into high-speed transmission as Gigabit Ethernet (GbE) and 10 Gigabit Ethernet (10GbE). GbE is standardised and internationally recognised in IEEE 802.3 (2002) and 10GbE in amendment IEEE 802.3ae (2002).

Ethernet looks back on a development history of 30 years, and counting. Ethernet today is not the probabilistic CSMA/CD bus with the disadvantages of collision and time delay uncertainty it used to be in the 80s. The new medium access control layer, connected in full duplex (only one sender and one receiver on one line), is based on switch technology, which handles access control. Full Duplex Ethernet allows the use of almost 100% of a link's physical bandwidth.

But Ethernet is not a LAN-only protocol anymore. Since the transmission rate was extended to 10 Gbit/s in June 2002, Ethernet applications are geographically entering the sector of long-distance transmission (Wide Area Networks, WAN). Admissible are only full duplex applications over optical fibers. Ethernet offers the advantage of a favourably cost-effective, easy implementation, and of a universal technology without protocol changes; strong arguments for using Ethernet in access networks and city networks (Metropolitan Area Networks, MAN) and then also in WANs.

Of key importance is the Metropolitan Area Network (MAN) because it is responsible for interconnecting high-speed LANs and for linking them to the global WAN. It is vital that no bottleneck situation occurs. 10GbE provides sufficient bandwidth in MANs – more than ADSL can offer in subscriber lines in the near future. ATM is the technology that has been predominant in access networks and MANs up to now. It has the advantage of guaranteeing a certain quality of service. With Ethernet it is simply assumed that sufficient bandwidth also ensures quality of service. The bandwidth is evidently achieved with optical networks.

## 2. Standardised fiber optic Gigabit and 10 Gigabit Ethernet applications

IEEE 802.3 and the Amendment IEEE 802.3ae define different Ethernet interfaces, depending on maximum supported distance and coding method. The basic designation of GbE is 1000BASE and 10GBASE of 10GbE. The more detailed designation, specifying the interfaces, follows the formula -wk(n).

The first letter w stands for wavelength: „S“ for short = 850 nm; „L“ for long = 1310 nm; „E“ for extra long = 1550 nm). The second letter k specifies the coding method. A distinction is made between the LAN methods in the proven 8B/10B coding, „X“, the new block coding 64B/66B, „R“, and the WAN method using SONET/SDH frames, designated „W“. The next digit, n, is optional and indicates the number of wavelengths used for WDM (Wavelength Division Multiplexing). If no number is indicated, only one wavelength is used.

	1000BASE	10GBASE		
Coding	LAN 8B/10B	LAN 8B/10B	LAN 64B/66B	WAN SONET
Short 850 nm	<b>1000BASE-SX</b> OM1 62.5 µm 275 m OM2 50 µm 550 m		<b>10GBASE-SR</b> OM1 62.5 µm 33 m OM2 50 µm 82 m OM3 50 µm 300 m	<b>10GBASE-SW</b> OM1 62.5 µm 33 m OM2 50 µm 82 m OM3 50 µm 300 m
Long 1300/1310 nm	<b>1000BASE-LX</b> OM1 62.5 µm 550 m OM2 50 µm 550 m OS1 9 µm 2 km	<b>10GBASE-LX4</b> MM 62.5 µm 300 m MM 50 µm 300 m OS1 9 µm 10 km	<b>10GBASE-LR</b> OS1 9 µm 10 km	<b>10GBASE-LW</b> OS1 9 µm 10 km
Extra long 1550 nm			<b>10GBASE-ER</b> OS1 9 µm 40 km	<b>10GBASE-EW</b> OS1 9 µm 40 km

Table 1: Application/wavelength, distance and fiber types for GbE and 10GbE. For more details on OM1, OM2 and OM3, see chapter 3

### 3. Structured cabling systems in accordance with ISO/IEC 11801 and EN 50173-1

The two authoritative standards in structured cabling systems were reissued in 2002; ISO/IEC 11801 (Information technology – generic cabling for customer premises) and EN 50173-1 (Information technology – generic cabling systems Part 1: general requirements and office areas). They were published shortly after the standardisation of 10GbE and include 10GbE applications over optical fibers.

#### 3.1. Optical channel definition

By definition a fiber optic channel starts at the output of the active sender (EQP, equipment) in the building distributor (BD) and ends at the input of the active terminal equipment (TE, terminal equipment). The plug connections at these devices are not part of it. Whether there is a floor distributor (FD) with patched or spliced connections in between or whether it is a direct cable between floor distributor and terminal equipment does not affect the definition. What has to be included to calculate the optical loss budget is simply the number of connections on the channel.

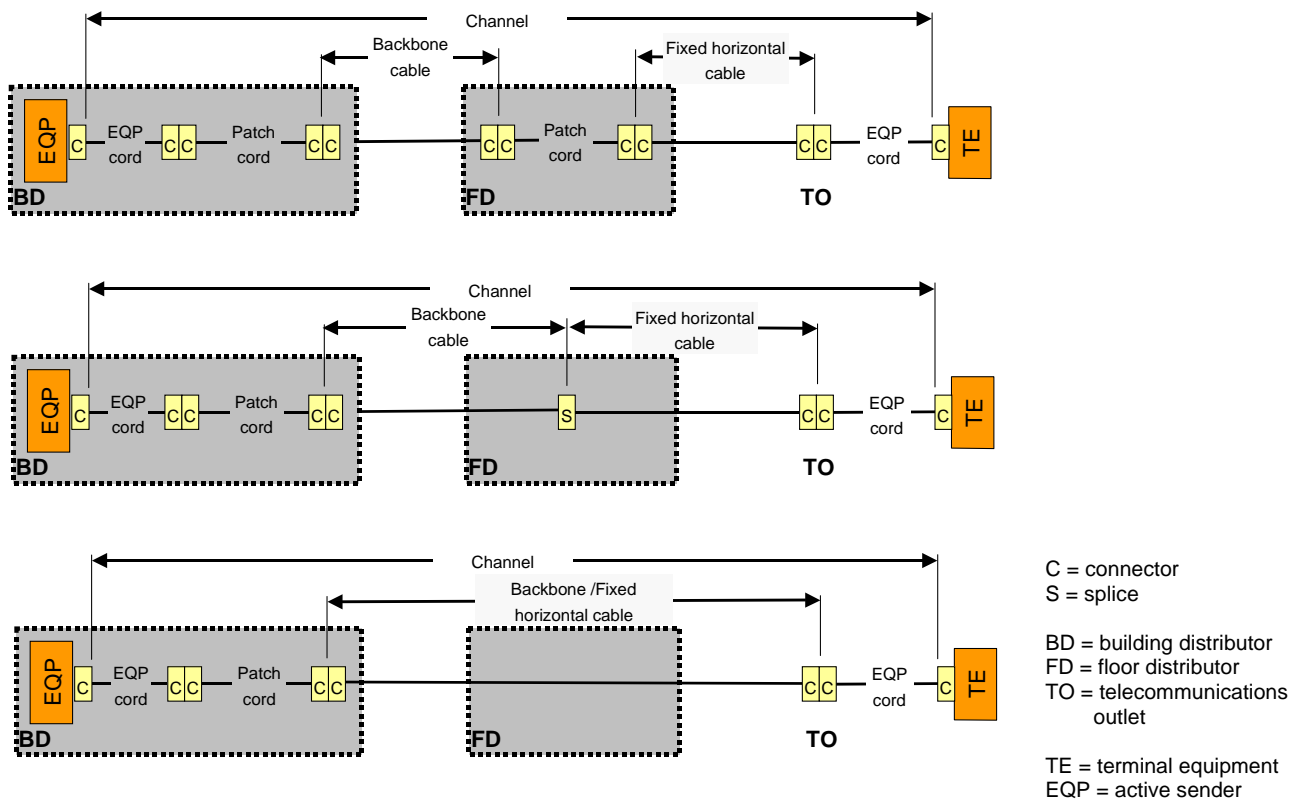

Figure 2: Supported channel structures

Basically, there are three defined length classes for fiber optic channels: OF-300 for a channel length of min. 300 m, OF-500 for min. 500 m and OF-2000 for min. 2000 m. The following maximum losses are admissible in these classes:

	Maximum channel loss [dB]			
	MM		SM	
Class	850 nm	1300 nm	1310 nm	1550 nm
<b>OF-300</b>	2.55	1.95	1.80	1.80
<b>OF-500</b>	3.25	2.25	2.00	2.00
<b>OF-2000</b>	8.50	4.50	3.50	3.50

Table 2: Channel loss according to ISO/IEC 11801 and EN 50173-1

These values are based on 1.5 dB for connecting hardware and maximum cable loss (see Table 3) of the corresponding length.

Example for an OF-500 with MM fiber at 850 nm: 1.5 dB connecting hardware + 500 m x 3.5 dB/1000 m = 3.25 dB

### 3.2. Multimode fiber categories

The multimode (MM) fibers specified for structured cabling systems are GI 50/125 µm and GI 62.5/125 µm corresponding to A1a and A1b in IEC 60753-2-10 (GI stands for graded index). This includes a number of fiber types (see Annex), divided into the three categories OM1, OM2, and OM3, differing only in their bandwidth characteristics:

	Maximum cable loss [dB/km]		Minimum modal bandwidth [MHz x km]		
	850 nm	1300 nm	Overfilled launch		Effective laser launch
			850 nm	1300 nm	850 nm
<b>OM1 (50 or 62.5µm)</b>	3.5	1.5	200	500	n.a.
<b>OM2 (50 or 62.5µm)</b>	3.5	1.5	500	500	n.a.
<b>OM3 (50µm)</b>	3.5	1.5	1500	500	2000

Table 3: MM fiber categories acc. to ISO/IEC 11801 and EN 50173-1

### 3.3. Singlemode fiber categories

Category OS1 is the only singlemode (SM) category today for structured cabling systems. It contains the fibers of type ITU-T G.652 and type B1 acc. to IEC 60793-2-50 and is specified as follows:

	Maximum cable loss [dB/km]		Cut-off wavelength
	1310 nm	1550 nm	
<b>OS1 (9µm)</b>	1.0	1.0	<1260 nm

Table 4: SM fiber category acc. to ISO/IEC 11801 and EN 50173-1

Presumably there will be a second SM category soon, called OS2. When the ISO/IEC 24702 „Generic Cabling for Industrial Premises“ was drafted, high-bitrate applications were discussed that went further than

the 2,000 m defined in ISO/IEC 11801, i.e. 5,000 m and 10,000 m. A corresponding category was proposed, basically describing the low-water peak fiber of type B1.3 from IEC 60793-2-50.

Wavelength [nm]	Maximum cable loss [dB/km]	PMD [ps/km]
1310	0.4	
1383-1385	0.4	
1550	0.4	0.4
1625	to be determined	

Table 5: Possible SM fibers of category OS2. For details on PMD see chapter 4

### 3.4. Plug connections

The connections in workspaces should be SC Duplex plug connections (SC-D) as in IEC60874-19-1. SC plug connections can also be used in the remaining areas or any plug connection specified in accordance with IEC. Small Form Factor (SFF) connectors can be used in the distributor. The following parameters are relevant:

#### Insertion loss (IL)

- ≤ 0.75 dB for 100% of the plug connections
- ≤ 0.5 dB for 95% of the plug connections

These two values resulted from a Gauss-distribution with the mean value of 0.35 dB, and randomly mated connectors and jacks. The values apply to SM and MM.

#### Return loss (RL)

- ≥ 20 dB for MM
- ≥ 35 dB for SM

Further details on mechanical and climatic performance are defined but not presented in detail here.

#### Colour coding

- Beige or black for MM 50 and 62.5 µm
- Blue for SM PC (physical contact; spherical polish)
- Green for SM APC (angled physical contact; angled polish)

This colour scheme applies to connectors and adapters in accordance with IEC60874-19-1 (SC Duplex) and IEC60874-14 (SC Simplex). With Duplex connectors additional mechanical coding ensures consistent polarity in the system. It is therefore recommended to terminate patch cords and equipment with duplex plug connectors. It is important that position A at one end is connected with position B at the other end.



Figure 3: Duplex patch cord

The optical fiber used in the channel should have identical geometric characteristics in all sections (backbone, permanent, link, patch cord, pigtail) and be of the same category.

### 3.5. Fusion splices

#### Insertion loss (IL)

≤ 0.3 dB for SM and MM

## 4. Optimised fibers for Gigabit and 10 Gigabit Ethernet applications

### 4.1. Increasing bandwidth with MM fibers of category OM3

Basically, a category OM3 fiber is a MM fiber with a very high bandwidth, specifically developed for high-bitrate transmission. The driving force behind this development was the fact that SM installations were too expensive for LANs ("overkill") and the possible link lengths of conventional MM fibers too short. The transmission of 10 Gbit/s over MM fibers only became realistic with this new development.

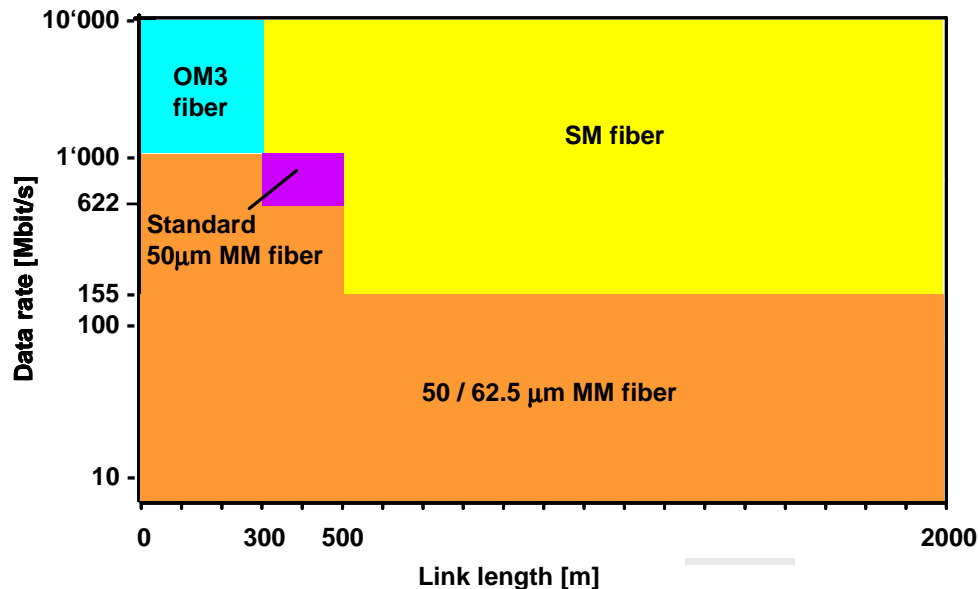

Figure 4: Link lengths and data rates of different fiber types

In high-bitrate transmission, bandwidth is not limited by loss but by dispersion. MM fibers are primarily affected by modal dispersion, SM fibers by chromatic dispersion (CD) and polarisation-mode dispersion (PMD).

The light impulses are broadened by dispersion while they're travelling along the fiber and flatten out. The longer the distance, the more pronounced the impulse broadening until the receiver can no longer separate and recognise the individual impulses. At that point the system is dispersion limited. The higher the data rate, the shorter the distance covered before dispersion limitation sets in. The data rate or bandwidth  $B$  is inverse proportional to the possible link length  $L$ , i.e. the bandwidth-length product ( $B \times L$ ) of a fiber is approximately constant.

The characteristic parameter for MM fibers is thus modal bandwidth, expressed in MHz x km. It denotes the transmission length possible with a given data rate before reaching a specified bit-error rate (BER). Typically this bandwidth is determined by launching light into a fiber from an LED; the measuring method is described in IEC 60793-1-41. With this type of light, all modes in an MM fiber are filled. The phenomenon is called overfilled launch (OFL). Due to differing propagation times of the modes, expressed as differential mode delay (DMD), transmission rates and transmission distances are limited.

LEDs cannot be used with applications above 1 Gbit/ because it exceeds their frequency limit. In long-distance transmission they are only used for applications up to 622 Mbit/s. Higher frequencies require the use of lasers. Theoretically, the bandwidth of an MM fiber is improved through light emitted by a laser, resulting in an underfilled launch (UFL). This only applies if the ideal refractive index profile is ideal.

In conventional MM fibers the ideal gradient profile is disturbed by dips, peaks, and flat tops in the area close to the centre. These inconsistencies increase signal distortion and the bit-error rate (BER); this effect is stronger the less modes are excited.

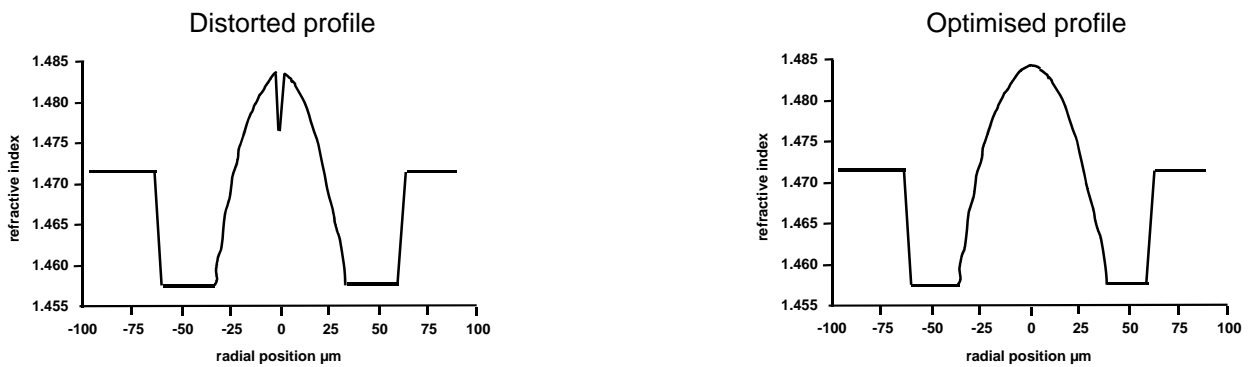

Figure 5: Graded index profile of an MM fiber of category OM3

A method to avert this effect is the offset launch with mode-conditioning cords, allowing the single-mode launch to be offset away from the centre of the MM fiber core. This launch method is required for example with 10GBase-LX4 (MM at 1300 nm) with wavelength division multiplexing (WDM).

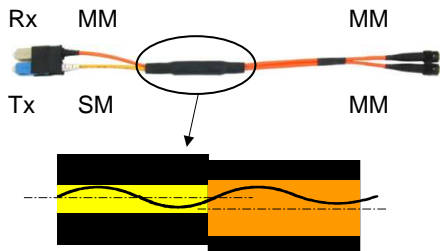

Figure 6: Mode conditioning

A more elegant counter-measure is offered by OM3 fibers with a laser-optimised refractive index profile near the fiber core. OM3 fibers are designed for the 1st optical window at 850 nm, like VCSELs (Vertical Cavity Surface Emitting Laser). A combination of the two is ideal for LANs. VCSELs are inexpensive semiconductor lasers with a beam diameter and beam divergence only significantly smaller than the LEDs, but slightly bigger than the expensive, narrow-band lasers, e.g. by Fabry-Perot or DFB lasers for SM fibers. VCSELs only excite modes near the fiber core.

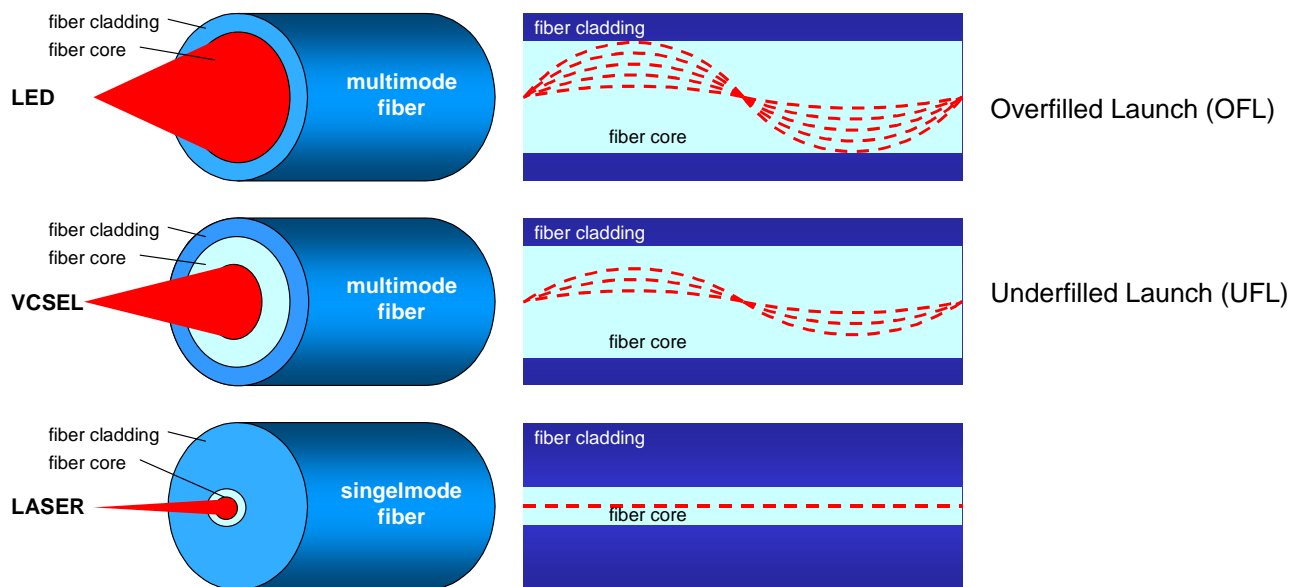

Figure 7: Launching light into MM and SM fibers

Combined, VCSEL and OM3 represent the most cost-effective system model for 10GbE over 300 metres, too. Plus they cost less than SM systems and WDM systems with conventional MM fibers. Consequently, in the medium and long term, no large-scale use of WDM or even DWDM (Dense Wavelength Division Multiplexing) is to be expected in LANs. Planning new installations must therefore always include OM3 fiber.

The effective bandwidth of OM3 fiber is determined by measuring six selectively excited mode groups; actually measured is the high-resolution differential mode delay. This also takes worst-case dispersion in a 10-Gigabit MM system into account.

Compared to standard MM fibers the splicing process needs only minor modifications; converting to OM3 fibers is practically complications-free.

Furthermore, OM3 fibers are backwards compatible. They ensure the use of LEDs at 100 Mbit/s (Fast Ethernet or Token Ring) today as well as a smooth, cost-effective conversion to future 1 Gbit/s and 10 Gbit/s, which means the investment maintains its value.

#### 4.2. SM fiber types and their use in Gigabit and 10 Gigabit Ethernet

The IEEE 802.3ae assumes the use of standard G.652 SM fibers (see Table 7) for SM applications with 10GbE. They fully comply with the requirements of 10GbE.

G.655 fibers even offer additional advantages that 10GbE not really requires. The IEEE 802.3ae briefly describes them like this: „It is believed that for 10BASE-E type B4 (NZDSF) fiber with positive dispersion may be substituted for B1.1 or B1.3.“

G.654 fibers find no application in GbE / 10GbE.

In 1310 nm transmission, fiber loss degrades the signal, limiting the transmission length so that the effects of chromatic dispersion (CD) are barely felt. In 10GbE at 1310 nm over G.652 fibers, CD is not a limiting problem either. It is only at 1550 nm and G.652 fibers that increased dispersion becomes a limiting factor; typically a 10GbE transmission is limited to 40 km.

G.652 and G.655 fibers specified according to today's level of standards allow a 10GbE-WAN application with regards to PMD. Fibers installed before the 90s on the other hand are likely to have poor PMD characteristics. Furthermore, links in long-distance network have developed over time and consist of various fiber types and connectors. CD and PMD measurements are therefore necessary before running 10GbE.

The factor of PMD will have to be given even more consideration if ultra high-speed applications of 40 or 100 Gbit/s should become realistic in the far future.

ITU-T	IEC 60793-2	Description / characteristics	ISO/IEC 11801 EN 50173-1
G.652	B1.1	Standard SM fiber, best used at 1310 nm, but is also suitable for 1550 nm. High dispersion at 1550 nm, requiring dispersion compensation with high bit-rates and/or long link lengths.	OS1
	B1.3	Low water peak fiber: the same dispersion characteristics as B1.1, but a strongly reduced loss in the extended band, meaning between the 2nd and the 3rd optical window. Therefore suitable for broad wavelength range with xWDM.	OS1
G.653	B2	Dispersion-shifted fiber: zero dispersion at 1550 nm, causing strong four-wave mixing in DWDM transmission. No commercial use.	-
G.654	B1.2	Cut-off shifted fiber; only suitable for 1550 nm; Area of application: submarine cables	-
G.655	B4	NZDSF to reduce or eliminate the four-wave mixing effects in DWDM systems at 1550 nm by means of a defined small dispersion coefficient that is unequal zero between 1530 and 1565 nm. NZDSF can also be used at 1310 nm in systems designed accordingly.	-

Table 6: Overview of fiber types and their designations in the different standards

## 5. Gigabit and 10 Gigabit Ethernet applications in ISO/IEC 11801 and EN50173-1

Table 7 provides an overview of the different fibers, their applications and possible link lengths:

Network applications	Supported by ISO/IEC 11801 and EN50173-1 Channel							
	OM1		OM2		OM3		OS1	
	850nm	1300nm	850nm	1300nm	850nm	1300nm	1310nm	1550nm
1000BASE-SX	*		OF-500		OF-500			
1000BASE-LX		OF-500		OF-500		OF-500	OF-2000	
10GBASE-LX4		OF-300		OF-300		OF-300	OF-2000	
10GBASE-ER/-EW								OF-2000
10GBASE-SR/-SW					OF-300			
10GBASE-LR/-LW							OF-2000	

\* 50µm fiber 550m (=OF-500); 62.5µm fiber 275m (no OF class)

Table 7: Application acc. to IEEE 802.3 and IEEE 802.3ae

## 6. The correlation between channel, class, bandwidth and loss

All values given in Tables 3, 4, 5 and 7 are worst-case values. The same applies to the parameters behind them; maximum admissible channel loss, required maximum cable loss, minimum bandwidth and maximum loss value of 0.75 dB for plug connections. They are the benchmark figures staking out an area where the proper function of an application is secured. The two opposing points are shown in the diagram below for the example of 1000BASE-SX with OM2 fiber:

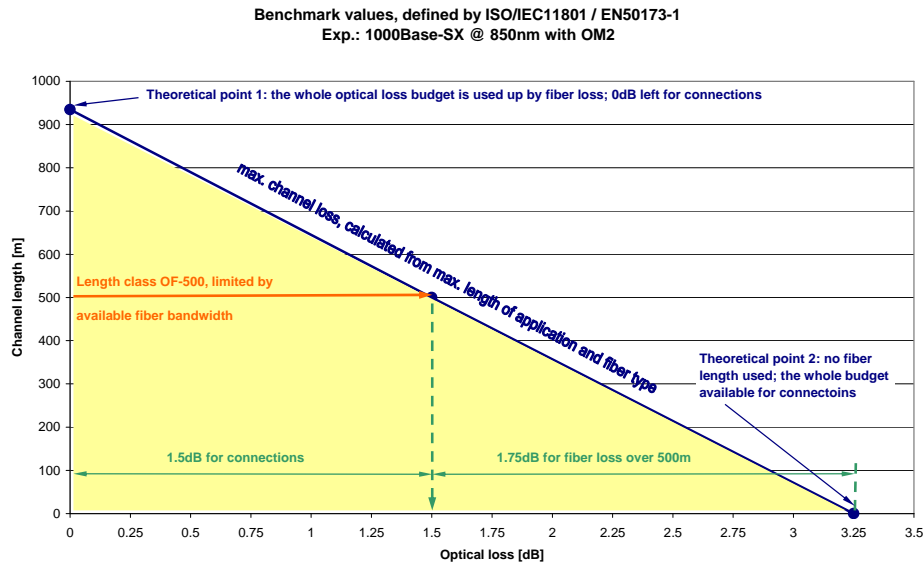

Figure 8

With a channel length of only 355 m in this installation example, the resulting reserve is 0.5 dB, which would be available for an additional plug connector for example. Figure 9 shows how such a reserve is achieved:

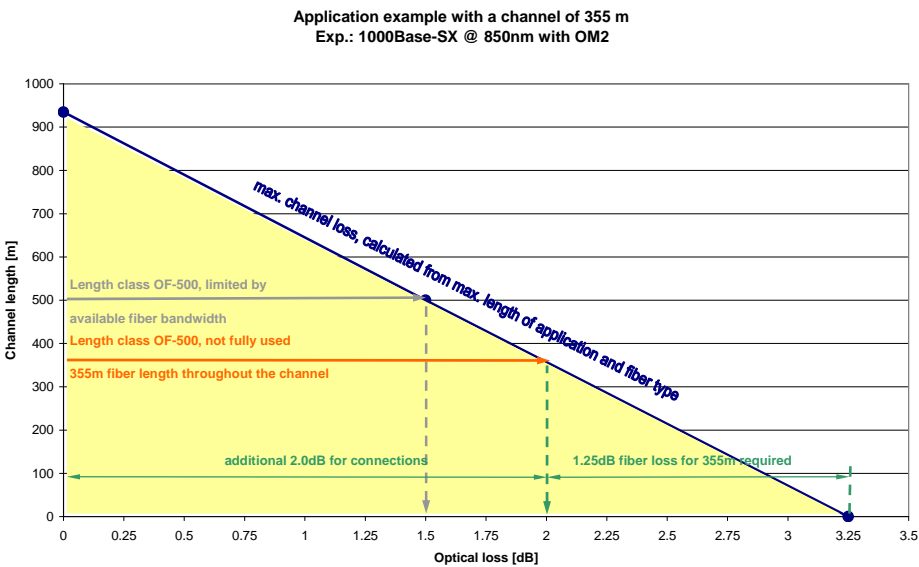

Figure 9

## Conclusions for R&M

### 6.1. Plug connector

It is not only important for a plug connector to comply with the minimum requirements specified in ISO/IEC 11801 und EN 50173-1. A reliable plug connection must also meet the parameters that guarantee the physical contact between the optical fibers. These are the radius of the spherically polished fiber end-face, the spherical fiber height with respect to the ferrule, and the apex offset, i.e. the excentricity of the highest point with respect to the fiber axis. R&M tests these parameters with an interferometer.

Another quality characteristic is number and size of scratches on the fiber's end-face. Here too, R&M follows the most stringent guidelines to avoid any loss in quality and to provide durable and dependable products.

R&M's product range features both the SC Duplex connector as well as the SFF connector SC-RJ. They are both mechanically and visually coded in accordance with standard specifications.

The SC-RJ connector is even equipped with an additional security system. An extended colour coding unmistakably indicates the connection's proper assignment, making erroneous connections impossible. Inadvertent and unauthorised disconnecting is also prevented, through mechanically locked plug-out protection. It can only be opened with the proper key and by authorised staff. Both plug-in and plug-out protection can be combined in a connector.

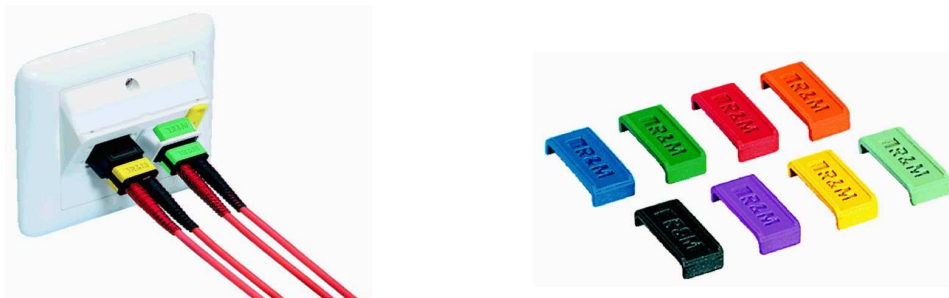

Figure 10: Security system. Left picture: colour coding for unequivocal plugging-in; plug-out protection preventing inadvertent and unauthorised disconnection. Right picture: colour coding clips – simply snapped onto the connectors.

In many respects R&M's plug connectors exceed the optical parameters specified in the standards by far. This fact ensures reserves in the entire system that is available for additional connections and longer distances.

### 6.2. Fiber loss

Loss characteristics of cables or fibers are usually better than prescribed by the standard. This means yet more reserve for additional connections.

### 6.3. Fiber bandwidth

The fiber types all have more bandwidth than specified in the standards. Provided channel loss is observed this allows going beyond minimum channel lengths.

Looking at the increasing data rates it is advisable to use 50  $\mu\text{m}$  fibers rather than 62.5  $\mu\text{m}$  – or simply the fiber with the highest bandwidth – in new installations and network renovations to secure reserves for future applications. In most cases OM3 fibers assure the highest investment protection. They are suitable for

today's protocols with LED-based transmission as well as laser-based GbE and 10GbE transmission, even with longer channel lengths than defined in IEEE 802.3ae.

Opinions differ as to whether all transmission links within a network should be type OM3, even the short patch cords. Basically, it is always best to use the same fiber type within one network, possibly even from the same manufacturer. On the other hand, dispersion in a link of approx. 3 m is nearly insignificant, and the patch cord has no critical effect on the bandwidth of the system as a whole.

#### 6.4. Example calculations

	Standard	Example 1	Example 2	Example 3	Example 4
<b>1000Base-SX: OF-500 with OM2 fiber</b>	<b>worst case</b>	<b>Shorter</b>	<b>Smaller</b>	<b>better</b>	<b>all three factors</b>
	<b>benchmarks</b>	<b>Channel</b>	<b>eff. fiber loss</b>	<b>connector</b>	<b>combined</b>
Budget [dB]	3.25	3.25	3.25	3.25	3.25
Length [m]	500	<b>355</b>	500	500	<b>355</b>
Fiber loss [dB/km] at 850nm	3.5	3.5	<b>2.8</b>	3.5	<b>2.8</b>
Number of connectors per channel	3	3	3	3	3
Loss per connector [dB]	0.50	0.50	0.50	<b>0.30</b>	<b>0.30</b>
Number of splices	0	0	0	0	0
Loss per splice [dB]	0.30	0.30	0.30	0.30	0.30
Loss for fiber [dB]	1.75	1.24	1.40	1.75	0.99
loss for connection [dB]	1.50	1.50	1.50	0.90	0.90
<b>Remaining loss from budget [dB]</b>	<b>0.00</b>	<b>0.51</b>	<b>0.35</b>	<b>0.60</b>	<b>1.36</b>
<b>Conclusion</b>	<b>worst case budget used up</b>	<b>E.g. one more connector!</b>	<b>E.g. one more splice possible!</b>	<b>E.g. two more splices possible!</b>	<b>E.g. reserve for future system expansion!</b>

Table 8

## 7. Prognosis

There is an ever stronger tendency towards using Ethernet in MANs. Based on market research R&M assumes that metro Ethernet equipment will increase by more than 100% until 2006. Ethernet allows service providers to offer flexible and reliable services at high bandwidths over a cost-effective medium. Not before long 10GbE will therefore enter the world of long-distance transmission too. It will first conquer access networks and maybe even the first/last mile. The advantage of a universal technology in LAN, MAN and WAN is its dispensing with electro-optical signals and protocol conversions, which both cause latency times – especially with high-speed transmission – and higher costs. In the WAN sector carriers will be able to use 10GbE in combination with DWDM. A peaceful coexistence of Ethernet, ATM, Fiber Channel and other technologies on one fiber pair is absolutely possible.

The future in long-distance transmission (>300 m) thus belongs to SM fibers. Performance of standard SM fibers acc. to G.652 is high enough for the city/access area, i.e. the first/last mile.

IEEE takes a concrete step in that direction. The task of the IEEE 802.3ah Working Group, headed by the EFM alliance, was to standardise Ethernet in the first mile (EFM). The group was working on these two main solutions:

### **P2P – point-to-point access over fiber optics**

For longer distances and smaller numbers of fibers:

100/1000Base-LX10: 2 fibers; 10 km;

100/1000Base-BX10 1 fiber with wavelength multiplexing; 10 km (sending/receiving at 1310/1490 nm)

Point-to-point connections allow covering long distances up to 40 km. Proprietary solutions even achieve 150 km.

### **P2MP – point-to-multipoint access over fiber optics**

For Ethernet Passive Optical Network (EPON);

Broadcasting; 1 fiber with wavelength multiplexing (downstream/upstream over 1270/1360 nm),

Upstream transmission over time slots for every subscriber,

Distribution to the houses through splitters

1000Base-PX10 up to 10 km

1000Base-PX20 up to 20 km

40 or even 100 Gbit/s will not become a reality for some time to come. A few obstacles with semiconductor components will have to be overcome first.

## 8. Annex: Further standardised MM fiber types

ISO/IEC 11801 and EN 50173-1 cabling standards define GbE/10GbE applications over fiber types A1a (50  $\mu\text{m}$ ) and A1b (62.5  $\mu\text{m}$ ). IEC 60793-2-10 standardises six graded index fibers by their differing bandwidth. There will be a new fiber type, called A1a.2, (see Draft IEC 60793-2-10 CDV). Some of these fibers can be assigned to the categories OM1, OM2 and OM3 according to their modal bandwidth characteristics:

Fiber type acc. to IEC 60793-2-10	Min. modal bandwidth at OFL @ 850 nm [MHz x km]	Min. modal bandwidth at OFL @ 1300 nm [MHz x km]	Category	Possible areas of application
A1a.1	200	400	–	low bit rate/short distance / patch cords
A1a.1	400	600	OM1	medium bit rate / medium distance
A1a.1	500	500	OM2	medium bit rate / medium distance
A1a.1	400	800	OM1	medium bit rate / medium distance
A1a.1	800	800	OM2	high bit rate / long distance
A1a.1	600	1200	OM2	high bit rate / long distance
A1a.2	1500 overfilled launch 2000 eff. mod. bandw.	500	OM3	very high bit rate (10 Gbit/s) / long distance / 850 nm optimised
A1b	100	200	–	low bit rate / short distance / patch cords
A1b	160	300	–	low bit rate / short distance
A1b	160 or 200	500	(OM1)	medium bit rate / medium distance
A1b	200	600	OM1	medium bit rate / medium distance
A1b	200	800	OM1	high bit rate / long distance
A1b	800	200	–	high bit rate / long distance 850nm optimised

Table 9